

OWNER'S MANUAL



Turn your day ahhh...round!



WARNING This product can expose you to chemicals including propylene oxide, which is known to the State of California to cause cancer and birth defects or other reproductive harm. For more information go to www.P65Warnings.ca.gov.



Conforms to ANSI/UL Std 1563
Certified to CSA Std C22.2 No. 218.1



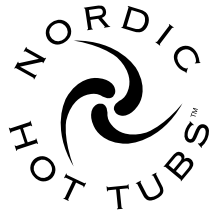

Thank You!

First and foremost, I appreciate your purchase of a Nordic Hot Tub. With so many brands available, we are humbled by your choice.

Nordic was founded in 1995 on 4 key principles which we still believe in and build into our product today. These principles are known by our employees and dealer partners across the globe as **S.T.A.R.** We believe every tub should be **S**imple, **T**herapeutic, **A**ffordable, and **R**eliable.

Rest assured, your new hot tub was hand-built with pride and craftsmanship second to none in the industry by a group of dedicated employees. Quality has always been our focus, hands on testing and quality control is the lifeblood of our company. Along with the craftsmanship, our team goes to extreme measures to only select the finest components from industry-leading vendors who believe in a level of quality like we do.

A great product is only as good as our great dealer network around the globe. Our dealer selection process is as stringent as our manufacturing process. Not just anyone can sell Nordic Hot Tubs, only the best will do when representing our brand.

We genuinely appreciate the opportunity to provide you with the best hot tub available and know your new hot tub will provide you therapeutic wellness, family enjoyment, and soulful relaxation for years to come.

Thank you for your purchase and welcome to the Nordic Hot Tub family!

Best Regards,

A handwritten signature in black ink, appearing to read "M Vozza".

Maurizio Vozza
Owner/CEO

TABLE OF CONTENTS

Important Safety Instructions.	4
Placement of Your Hot Tub	6
Power Installation Instructions and Requirements	7
Quick Start Guide.	13
Operating Instructions	15
Diagnostic Messages	17
Operating the rest of the Hot Tub	18
Troubleshooting.	22
Water Treatment Instructions.	23
Understanding Hot Water Chemistry	24
Common Water Q&A	26
Periodic Cleaning and Care.	27
Winterizing Your Hot Tub	28
Warranty Registration	29
Quick Reference by Model / Voltage & Amps by Series.	31

Your Owner's Manual Provides Important Safety Information.
PLEASE SAVE THESE INSTRUCTIONS.

N.P.I.
4655 Patterson Ave. SE, Grand Rapids, MI USA 49512

IMPORTANT SAFETY INSTRUCTIONS

PLEASE READ AND FOLLOW ALL INSTRUCTIONS.

DANGER- Risk of drowning

DANGER – Risk of Accidental Drowning. Extreme caution must be exercised to prevent unauthorized access by children. To avoid accidents, ensure children cannot use this hot tub unless they are supervised at all times.

WARNING: Hot tub covers are equipped with clip tie-downs or snap locks. There is no representation the cover tie-downs or snap locks will prevent access to the hot tub. Cover locks are to discourage unsupervised children from entering the hot tub and to secure cover in high-wind conditions.

WARNING: DO NOT USE SPAS OR HOT TUBS UNLESS ALL SUCTION GUARDS ARE VGB COMPLIANT AND INSTALLED TO PREVENT BODY AND HAIR ENTRAPMENT.

- Risk of drowning or injury. The suction fittings in this hot tub are sized to match the specific water flow created by the pump. Should the need arise to replace the suction fittings or the pump, be sure the flow rates are compatible and the replacement cover is VGB compliant. (Virginia Graeme Baker Pool and Spa Safety Act) Never operate hot tub if the suction fittings are broken or missing. Never replace a suction fitting with one which is not VGB compliant or rated less than the flow rate marked on the original suction fitting.

DANGER- Risk of injury

WARNING – To reduce the risk of injury:

- The water in a hot tub should never exceed 40°C (104°F). Water temperatures between 38°C (100°F) and 40°C(104°F). are considered safe for a healthy adult. Lower water temperatures are recommended for young children and when hot tub use exceeds 10 minutes.
- Pregnant (or possibly pregnant) women should consult with their physician before entering
- Since excessive water temperatures have a high potential for causing fetal damage during the early months of pregnancy, pregnant or possibly pregnant women should limit spa water temperatures to 38°C (100°F).
- Before entering a hot tub, the user should measure the water temperature with an accurate thermometer since the tolerance of water temperature-regulating devices varies.

- The use of alcohol, drugs, or medication before or during hot tub use may lead to unconsciousness with the possibility of drowning.
- Obese persons and persons with a history of heart disease, low or high blood pressure, circulatory system problems, diabetes, or any condition requiring medical treatment should consult a physician before using a hot tub.
- Persons using medication should consult a physician before using a hot tub since some medication may induce drowsiness while other medication may affect heart rate, blood pressure, and circulation.
- Do not use hot tub immediately following strenuous exercise
- Individuals with infectious diseases should not use a spa or hot tub
- Please use caution when entering or exiting spa or hot tub
- Prolonged immersion in spa or hot tub may be hazardous to your health
- Never jump or dive into you hot tub

DANGER- Risk of Hyperthermia

- **WARNING:** Prolonged immersion in hot water may induce hyperthermia. Hyperthermia occurs when the internal temperature of the body reaches a level several degrees above the normal body temperature of 98.6°F (37°C). The symptoms of hyperthermia include drowsiness, lethargy, and an increase in the internal temperature of the body. The effects of hyperthermia are:
 - Unawareness of impending hazard;
 - Failure to perceive heat;
 - Failure to recognize the need to exit the hot tub;
 - Physical inability to exit the hot tub;
 - Fetal damage in pregnant women;
 - Unconsciousness and danger of drowning.

WARNING: THE USE OF ALCOHOL OR DRUGS CAN GREATLY INCREASE THE RISK OF FATAL HYPERTHERMIA IN HOT TUBS OR SPAS.

DANGER- Risk of electric shock

CAUTION – Risk of Electric Shock- do not leave compartment door open.

CAUTION – Risk of Electric Shock- replace components only with identical components.

WARNING – Prevent Electrocution:

- Do not connect any auxiliary components (for example cable, additional speakers, headphones, additional audio/video components, etc.) to the system.
- Do not permit electric appliances (such as a light, telephone, radio, or television) within 1.5M (5 ft) of this hot tub
- These units are not provided with an outdoor antenna; when provided, it should be installed in accordance with Article 810 of the National Electrical Code, ANSI/NFPA 70.
- Do not service this product yourself as opening or removing covers may expose you to dangerous voltage or other risk of injury. Refer all servicing to qualified service personnel.
- When the power supply connections or power supply cord(s) are damaged; if water is entering the audio/video compartment or any electrical equipment compartment area; if the protective shields or barriers are showing signs of deterioration; or if there are signs of other potential damage to the unit, turn off the unit and refer servicing to a qualified service personnel.
- This unit should be subjected to periodic routine maintenance (for example, once every 3 months) to make sure that the unit is operating properly.

WARNING: When using this electrical equipment, basic safety precautions should always be followed, including the following:

- A green colored terminal or a terminal marked G, GR, Ground, Grounding, or with the  symbol is located inside the supply terminal box or compartment. To reduce the risk of electric shock, this terminal must be connected to the grounding means provided in the electric supply service panel with a continuous copper wire equivalent in size to the circuit conductors supplying this equipment.
- At least two lugs marked "BONDING LUGS" are provided on the external surface or on the inside of the supply terminal box or compartment. To reduce the risk of electric shock, connect the local common bonding grid in the area of the hot tub or spa to these terminals with an insulated or bare copper conductor not smaller than No. 6 AWG (13 mm²).
- All field-installed metal components such as rails, ladders, drains or other similar hardware within 1.5 m(5 ft) of the spa or hot tub shall be bonded to the equipment grounding bus with copper conductors not smaller than No. 6 AWG (13 mm²).

CAUTION: TEST THE GROUND FAULT CIRCUIT INTERRUPTER BEFORE EACH USE OF THE SPA.

Please read through this again and SAVE THESE INSTRUCTIONS
(we care about your safety!)

PLACEMENT OF YOUR HOT TUB

There are several items to consider before deciding on a location for your new hot tub. We've listed a few of them below.

1. **PERMISSION:** your state, province, city, township, or association may have rules related to access, construction permits, fences, gates, and delivery methods and routes. Please check with them to make sure your plans meet their criteria. Don't forget to look for power lines if a crane needs to place the hot tub on a raised location.
2. **SUPPORT:** It is extremely important the base on which the hot tub is placed is smooth, level, and can uniformly support the complete weight without settling or shifting. If these requirements are not met, possible damage to your cabinet or tub shell may result. ***Damage caused by improper support is not covered under warranty.*** It is the responsibility of the hot tub owner to meet these requirements and to assure the integrity of the hot tub support at all times. A level concrete slab or a well-supported wood deck (built to code) is ideal.
3. **DRAINAGE:** Don't forget the water will occasionally need to be drained. Make sure that you don't have sensitive vegetation or erosion concerns. A regular garden hose can be attached to the drain fitting so the old water can be directed to an appropriate area. A small submersible pump can also be used. Also, make sure rain water and snow melt is directed away from the base of your new hot tub. External water damage from flooding may damage the electronics and pump which will void your warranty.
4. **ACCESS:** if you have decided to drop your new hot tub into a deck (which looks great and makes it easy to get in and out of), you will eventually need to remove the service panel (on the same side as the topside control) to access the drain or the equipment pack. You can provide access via a lift-out section of the deck or position the access panel at an outside edge of your deck. Check with your builder for additional ideas they may have.
5. **THE PATH:** a nice clean path is best so sand, mud, and grass clippings aren't tracked into your new hot tub. Tracked-in dirt makes keeping the water sparkling clean and properly balanced a challenge.
6. **THE VIEW:** take things like the intended use and number of users into consideration. If it is intended for relaxation or a quiet night for 2, then a cozy corner with the view of a lake or mountain, etc. would be great. Don't forget to take the view of your neighbors into consideration as well. If it will be used for play time for the kids and their friends, make sure to leave plenty of room around it for climbing in and out and access to toys.
7. **THE WEATHER:** if you live in a Northern region like we do, it is a great idea to place the hot tub close to a doorway to reduce your time in the cold and snow.

NOTE: Please keep your hot tub covered whenever it is not being used- especially when it is empty. The shell surface can be damaged if it is left dry and exposed to direct sunlight.

POWER INSTALLATION INSTRUCTIONS

WIRING LOCATIONS

Some installations work best to drill a hole in the side panels and others require the wiring to come up from the bottom. We've included line drawings with approximate "safe" locations for the wiring to be plumbed in from the bottom. Please reference the following drawings.

IMPULSE, SPORT, CROWN II & IMPULSE DP

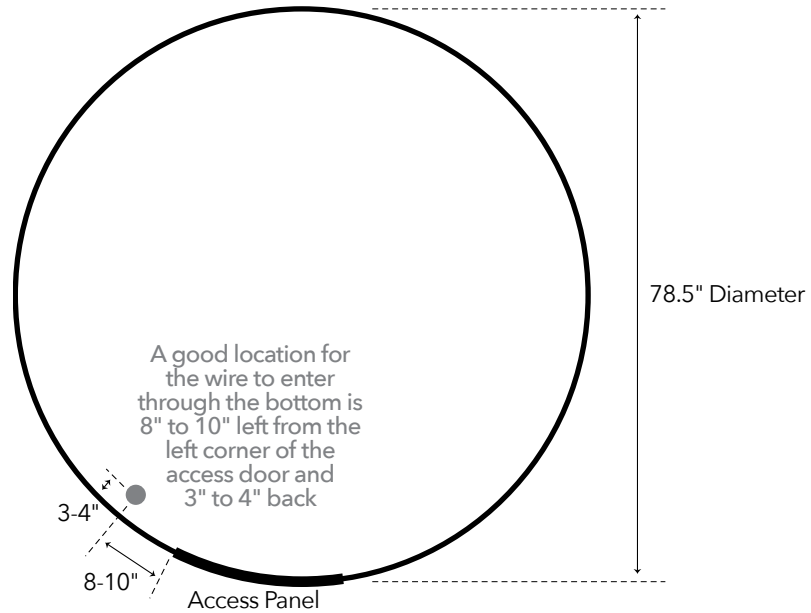

CROWN, WARRIOR XL & CROWN XL

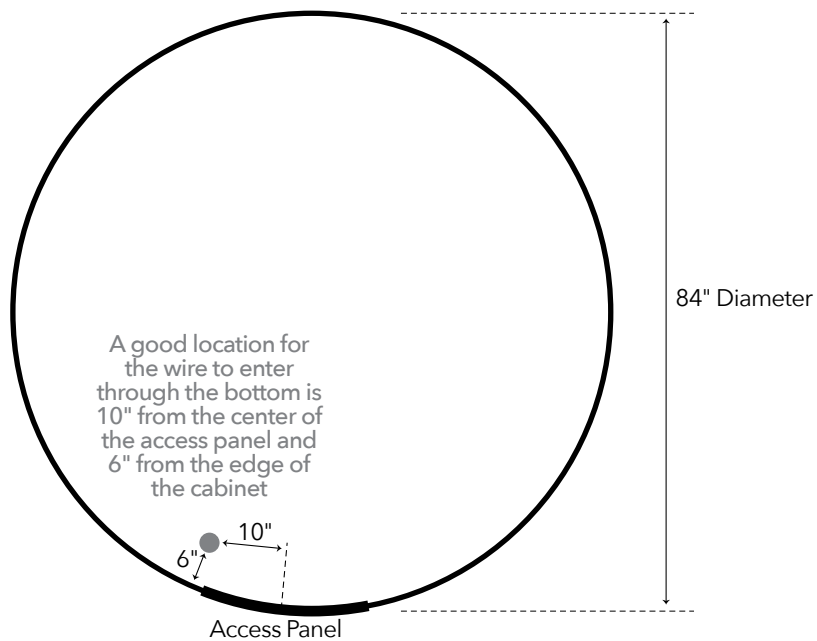

POWER INSTALLATION INSTRUCTIONS CONTINUED

BELLA

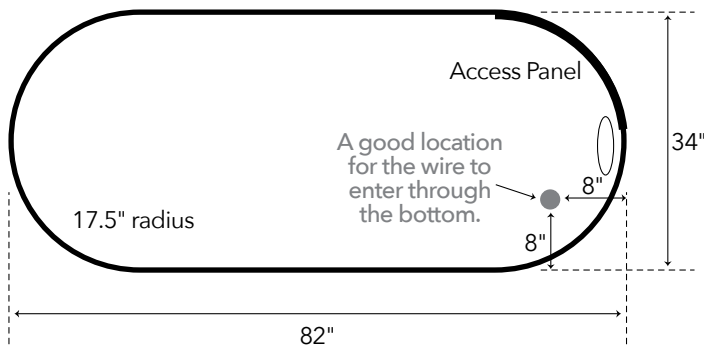

D'AMOUR

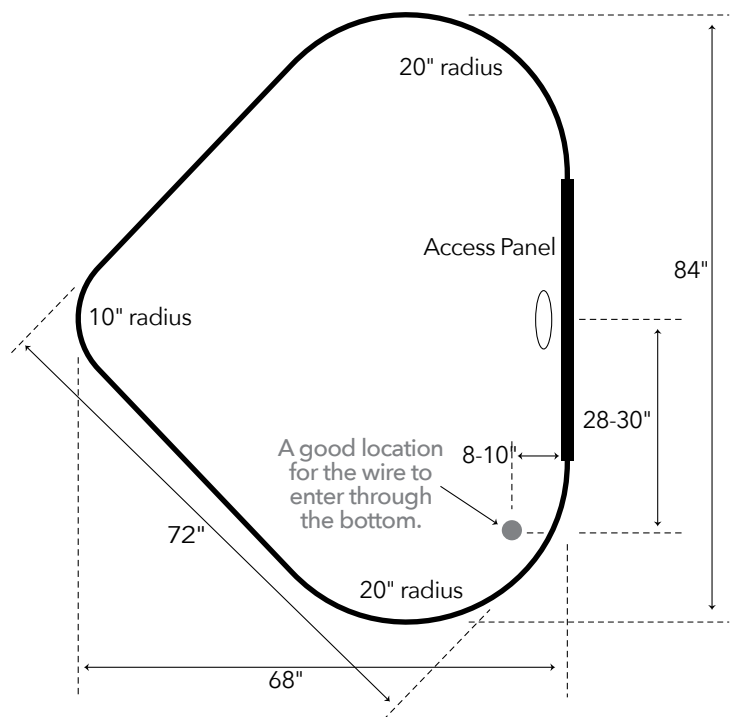

RETREAT

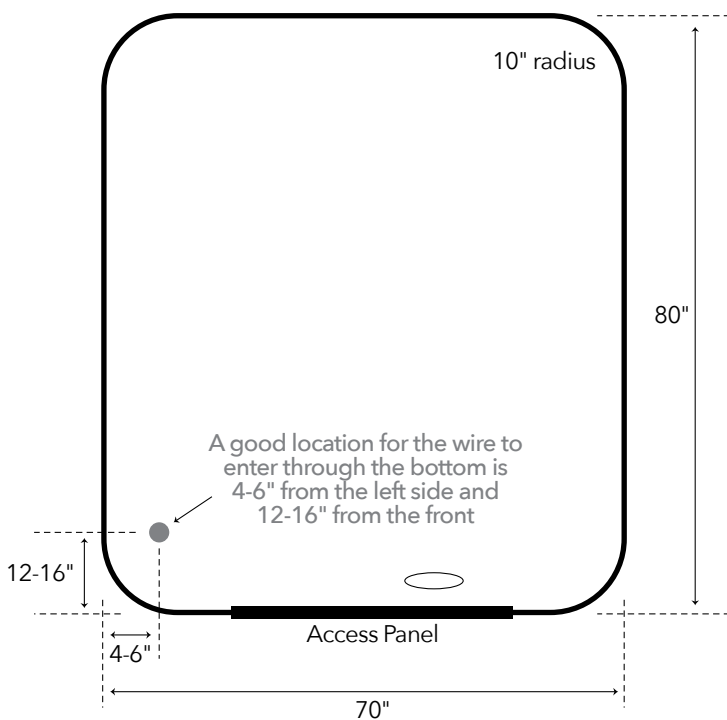

ESCAPE

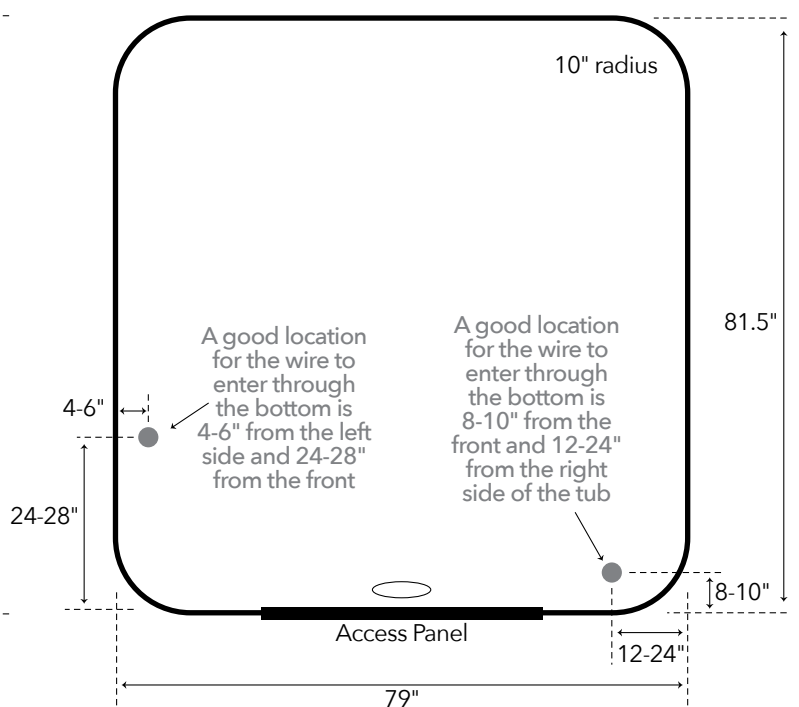

STELLA

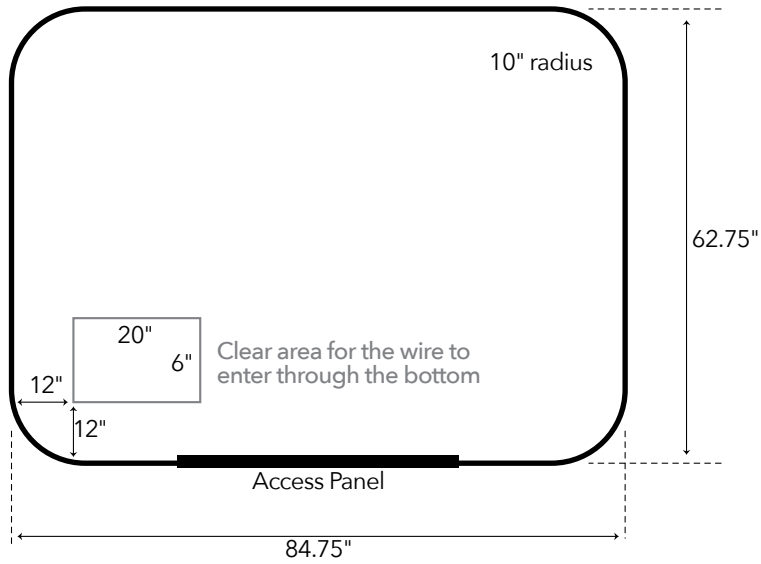

RENDEZVOUS

ENCORE & JUBILEE

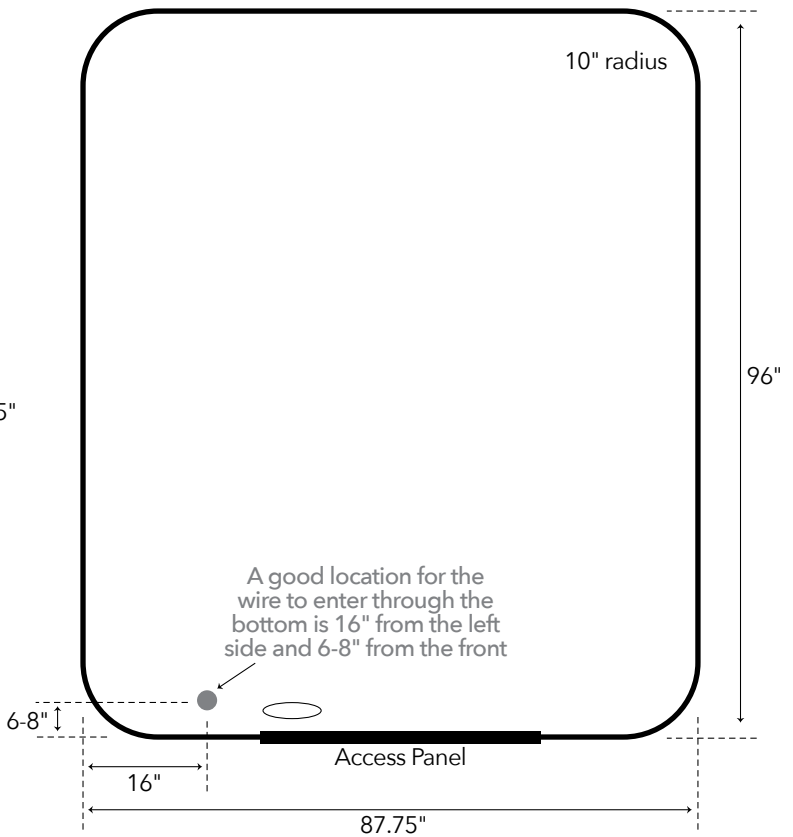
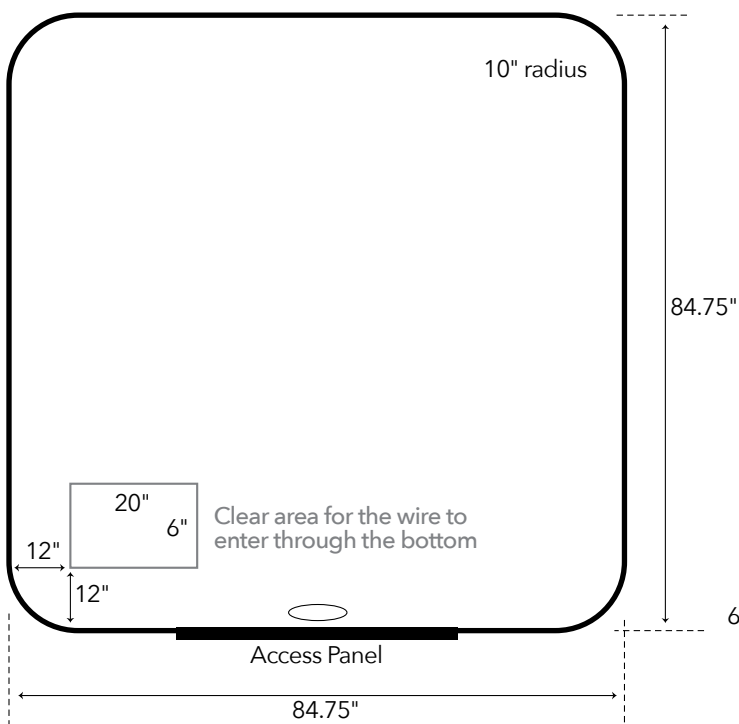

POWER INSTALLATION INSTRUCTIONS CONTINUED

ELECTRICAL WIRING INSTRUCTIONS

Important Notice: The electrical installation of this tub must meet the requirements of all applicable country, province, state, and local codes. The electrical installation must be performed by a qualified, licensed electrician and be approved by the local building/electrical inspection authority.

WARNING: DO NOT TURN ON POWER UNTIL TUB IS FILLED COMPLETELY WITH WATER!

240 VOLT SERVICE

- NO PLUG-IN CONNECTIONS OR EXTENSION CORDS ARE TO BE USED IN CONJUNCTION WITH THE OPERATION OF THIS TUB. All wiring must be permanently connected (hard wired) to the equipment pack. **Power supply that is not in accordance with these instructions will void warranty.**
- This tub requires the power supply be on a dedicated circuit with no other electrical appliances or lights sharing the circuit that is providing power to the hot tub.
- DO NOT USE ALUMINUM WIRE.
- ALL WIRING MUST BE COPPER and properly insulated.
- A suitable ground fault circuit interrupter (GFCI) as required by the local building and electrical inspection authority, must be included in the electrical circuit supplied to the hot tub.
- Proper wire size must be used in accordance to the local building/ electrical inspection authority.
- All wires must be securely hooked up or damage could result. **TIGHTEN SECURELY!**
- A minimum of 6 gauge wire size must be used between the GFCI and the hot tub system connection
- Wire runs of under 50 feet may use 8 gauge wire. Please verify local code requirements
- Any mis-wiring may void your warranty. Please reference the included wiring diagram for the correct connections.

240 VOLT CONVERSION (Classic and Modern Series)

The Classic and Modern Series hot tubs have been configured to be connected to 120 volts. They can be converted to be wired to 240 volts by following the following steps:

1. Make sure that the power has been switched off at the main breaker
2. Remove the Cabinet Access Panel
3. Remove the system controller cover
4. Remove the jumper connecting J11 and J32.
5. Switch DIP switch A10 to off (down).
6. Wire the controller as outlined in the 240volt wiring instructions
7. Attach system controller cover
8. Attach Cabinet Service Panel

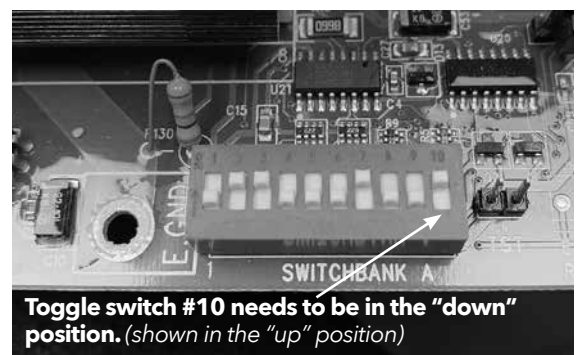
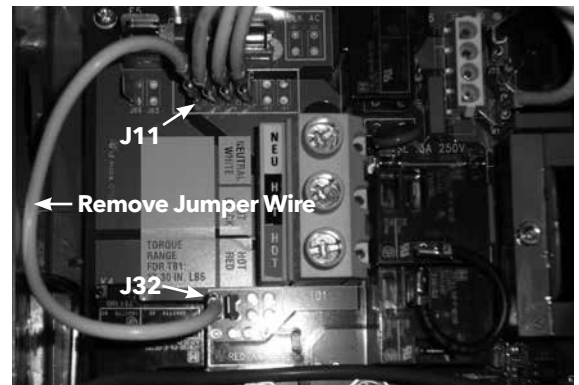

240V WIRING SCHEMATIC

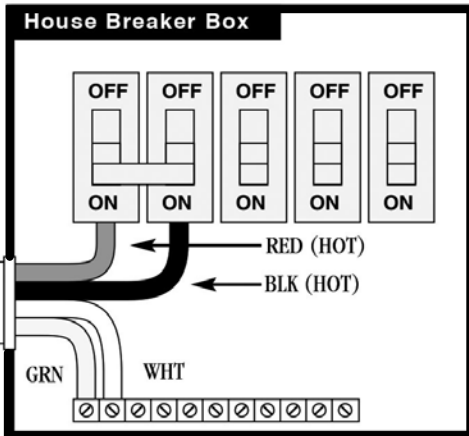

IMPORTANT: Copper wires must be stripped back 3/4" for terminal block inside hot tub control box. Failure to do so may result in poor connection.

3/4"

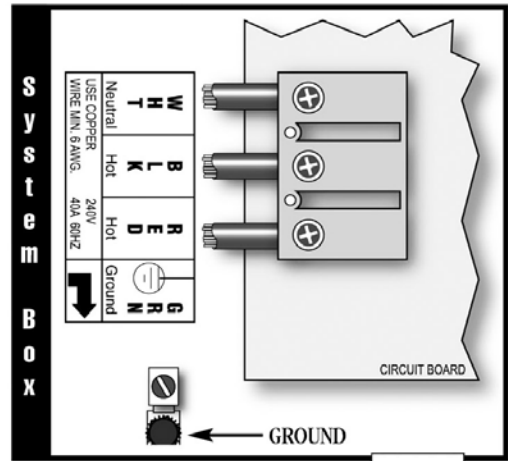
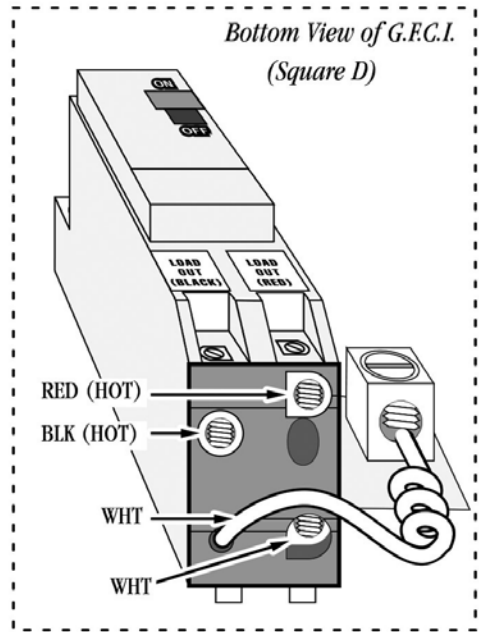
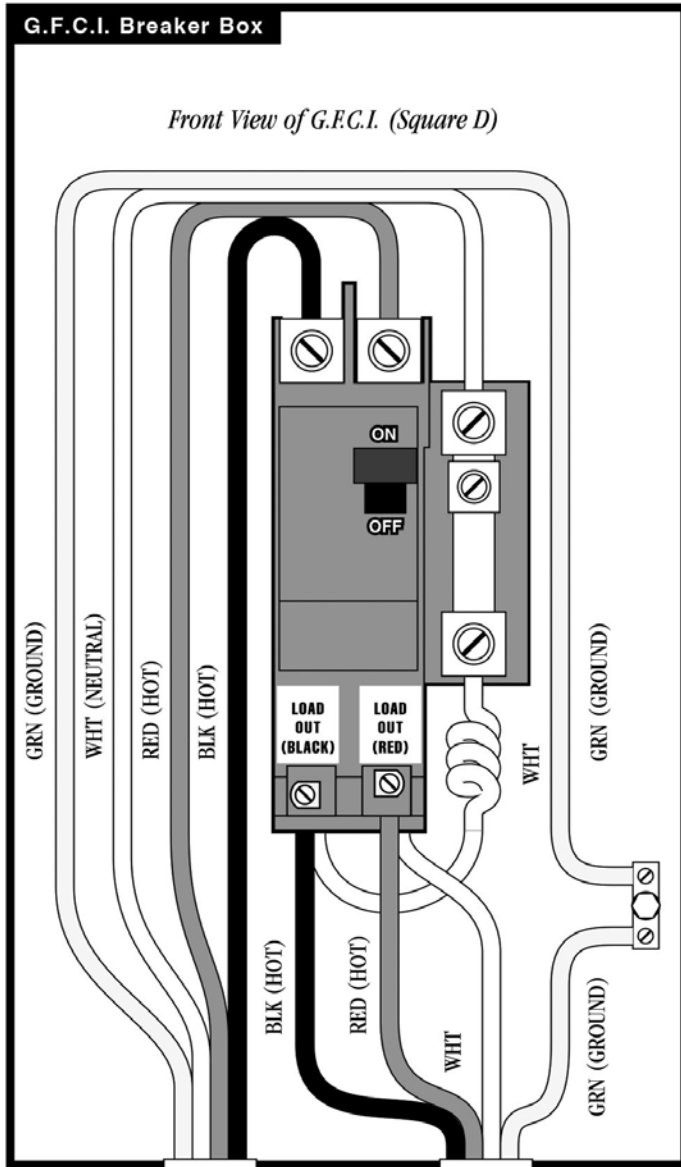

POWER INSTALLATION INSTRUCTIONS CONTINUED

120 VOLT CORD CONNECTION OPTION *(110-all-in, Classic and Modern Series)*

The cord connection option is only available for 120V operation on the models rated 12/15 A. Only the manufacturer recommended power cord and GFCI should be used for cord connected installations. Only plug the cord into a **dedicated** 120V/15 amp receptacle after following the steps below.

Electrical installation should be performed by a qualified, licensed electrician.

Warning: Make sure that cord is unplugged from the wall socket prior to proceeding with the following steps.

1. Remove cabinet service panel. The panel is secured with Phillips Head truss machine screws.
2. Remove system controller cover.
3. If spa was manufactured with a cord, disconnect cord wires from terminal TB1 and ground wire from ground bar.
4. Loosen cord strain relief.
5. Remove cord.
6. Remove strain relief.
7. Drill hole for conduit through bottom or side of spa.
8. Secure conduit at system controller box.
9. Connect hot and neutral wires to corresponding terminals TB1. Connect ground wire to grounding bar on the outside of box by running it through hole marked for ground wire. Double check that all electrical connections are tight.
10. Reinstall system cover and hot tub access panel.



WARNING: DO NOT TURN ON POWER UNTIL TUB IS FILLED COMPLETELY WITH WATER!

HOT TUB ANATOMY

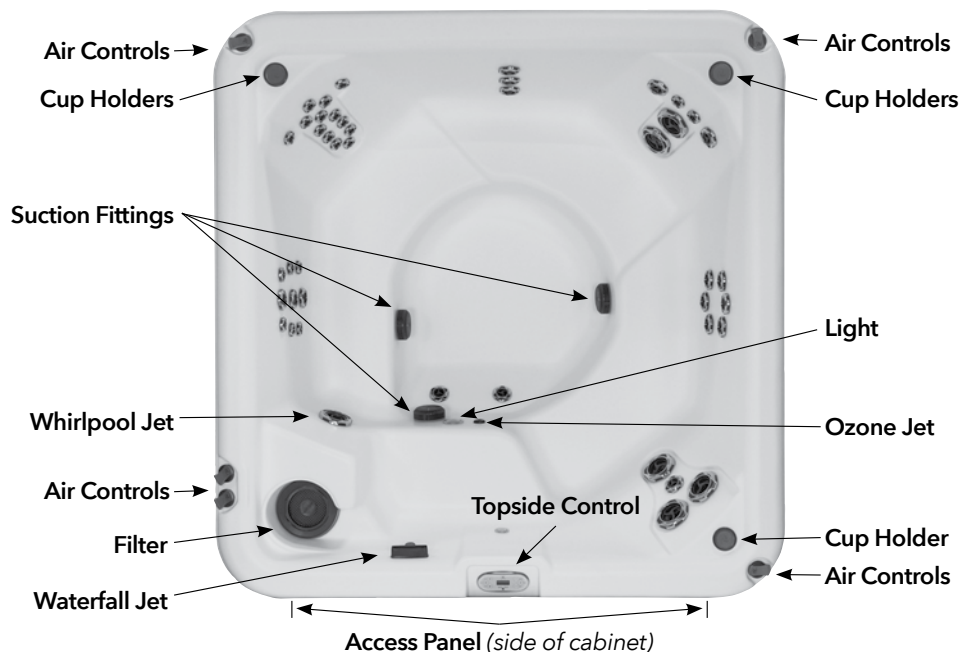

QUICK START GUIDE

1. Wipe down the hot tub interior if needed.
2. Open access panel by removing Phillips Head truss machine screws.
3. Use a garden hose to fill your hot tub through the empty filter canister (to avoid air pockets during filling) to a minimum level of 2 inches (5.08cm) over the filter skimmer.

Note: CITY OR WELL WATER IS PREFERRED. DO NOT USE WATER THROUGH A WATER SOFTENER.

- If your hot tub has a **floating weir**, pull the weir straight up and then rotate the filter counter-clockwise until it is free and can be pulled straight out. NOTE: The floating weir floats up and down with the water level.



- If your hot tub has a **visible basket**, rotate the basket counter-clockwise to remove it. The filter will pull straight out.



4. Locate the shut-off T-valves. Make sure they are in the up or open position.



QUICK START GUIDE CONTINUED

5. Check heater and pump unions. Occasionally during shipping these become loosened. A simple tightening of these (if necessary) will do, being careful not to over tighten.

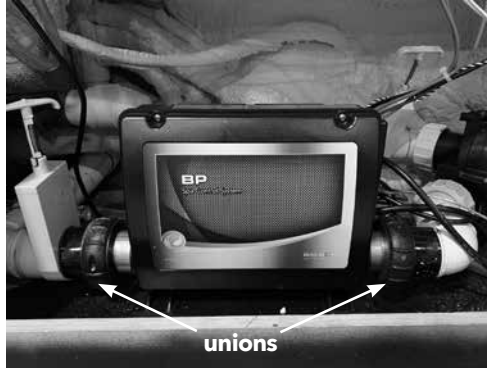
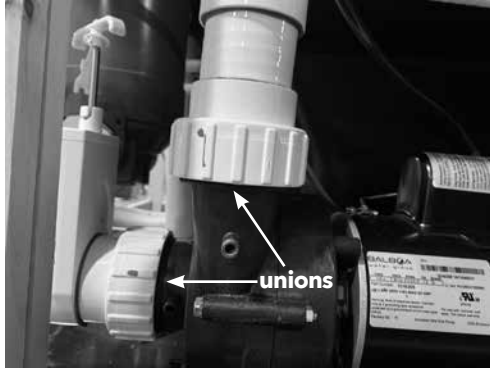

6. Once water has reached correct level, remove the garden hose, replace the filter and basket or floating weir and turn power on to the hot tub.
7. To activate jets and to purge air from the pump, press/push Jet 1 button located on the top side control. A second press/push will put the pump on high speed. Repeat this process until water flows from the jets. When the jets are working, set the pump to low speed.
8. Add chemicals to your water prior to heating the water. Please see your dealer for recommendations.
9. Set the temperature located on the top side control to the desired setting. The heater will shut off when the water temperature reaches the set temperature. Default is 100°F.
10. Place the hot tub cover on tub. Keeping the cover on the hot tub when the tub is not in use will help minimize operating costs.
11. The time it will take for the water temperature to reach the desired setting will vary.

OPERATING INSTRUCTIONS

SINGLE PUMP SYSTEM

INITIAL START-UP

Your spa will enter Priming Mode (Pr) when it is energized. **During Priming Mode, press "Jets" button repeatedly and be sure the pump is free of air.** Priming Mode lasts less than 5 minutes. Press "Warm" to exit. After Priming Mode, the spa will run in Standard Mode (see Mode section).



Controller used on All-In-110 Series and Bella Models

Pump 1 low-speed is responsible for heating and filtration and will be referred to simply as the pump.

In multi-button sequences, if the buttons are pressed too quickly in sequence, they may not register.

Low speed pump will run every 30 minutes from 2 to 5 minutes to check the tubs water



Controller used on Classic, Modern, and Sport Series

▲ ▼ TEMP CONTROL (80°F - 104°F / 26°C - 40°C)

The last measured water temperature is constantly displayed. The water temperature displayed is current only when the pump has been running for at least 1 minute. To display the set temperature, press "Warm" or "Cool" once. To change the set temperature, press a temperature button again before the display stops flashing. Each press of "Warm" or "Cool" will adjust the set temperature. After three seconds, the display will stop flashing and begin to display the current spa temperature.

🌀 JETS

Press "Jets" to turn the pump on or off, and to shift between low and high speeds. If left running, the pump will turn off after a preset length of time of 2 hours for low speed and 15 minutes for high speed. Low speed may run automatically at times, during which it cannot be deactivated from the panel, but high speed may be operated. The ozone generator (if installed) will activate anytime low speed is running.

☀️ LIGHT

Press "Light" to operate the spa light. Turns off after 4 hours.

PRESET FILTER CYCLES

The first preset filter cycle begins 6 minutes after the spa is energized. The second preset filter cycle begins 12 hours later. Filter duration is programmable for 1, 2, 3, 4, 5, 6, 7, or 8 hours. The default filter time is 1 hour. To program, press "Warm" then "Jets." Press "Warm or Cool" to adjust. Press "Jets" to exit programming.

AUTOMATIC POLLING (in Standard Mode)

The pump will activate for 2-5 minutes every 30 minutes to check the temperature. This also happens whenever the temperature is adjusted.

OPERATING INSTRUCTIONS CONTINUED

TWO PUMP SYSTEM (LUXURY SERIES CONTROLLER)

INITIAL START-UP

Your spa will enter Priming Mode (Pr) when it is energized. **During Priming Mode, press "Jets" button repeatedly and be sure the pump is free of air.** Priming Mode lasts less than 5 minutes. Press "Warm" to exit. After Priming Mode, the spa will run in Standard Mode (see Mode section).

Pump 1 low-speed is responsible for heating and filtration and will be referred to simply as the pump.

In multi-button sequences, if the buttons are pressed too quickly in sequence, they may not register.

Low speed pump will run every 30 minutes from 2 to 5 minutes to check the tubs water



▲ ▼ TEMP CONTROL (80°F - 104°F / 26°C - 40°C)

The last measured water temperature is constantly displayed. The water temperature displayed is current only when the pump has been running for at least 2 minutes. To display the set temperature, press "Warm" or "Cool" once. To change the set temperature, press a temperature button again before the display stops flashing. After three seconds, the display will stop flashing and begin to display the current spa temperature.

🌀 JETS 1

Press "Jets 1" to turn pump 1 on or off, and to shift between low and high speeds. The low-speed will turn off after 4 hours. High-speed will turn off after 15 minutes. Low-speed may run automatically at times, during which it cannot be deactivated from the panel, but high-speed may be operated.

🌀 JETS 2

Press "Jet 2" to turn pump 2 on and off. This pump will turn off after 15 minutes.

☀️ LIGHT

Press "Light" to operate the spa light. Turns off after 4 hours.

✳️ MODE

Mode is changed by pressing "Warm" or "Cool," then pressing "Mode."

Standard Mode maintains set temperature. Std will be displayed momentarily when you switch into Standard Mode.

Economy Mode heats the spa to the set temperature only during filter cycles. "Ecn" will display when water temp is not current, and will alternate with water temp when the pump is running.

Sleep Mode heats the spa to within 20°F/10°C of the set temperature only during filter cycles. SLP will display when water temp is not current, and will alternate with water temp when the pump is running.

PRESET FILTER CYCLES

The first preset filter cycle begins 6 minutes after the spa is energized. The second preset filter cycle begins 12 hours later. Filter duration is programmable for 2, 4, 6, or 8 hours or for continuous filtration (indicated by FILC). The default filter time is 2 hours. To program, press "Warm" or "Cool," then "Jets 1." Press "Warm" or "Cool" to adjust. Press "Jets 1" to exit programming. Low-speed pump 1 and the ozone generator (if installed) run during filtration.

AUTOMATIC POLLING (in Standard Mode)

The pump will activate for 2-5 minutes every 30 minutes to check the temperature. This also happens whenever the temperature is adjusted.

DIAGNOSTIC MESSAGES

MESSAGE		MEANING	ACTION
1 Pump	2 Pump	No message on display. Power has been cut off to the spa.	The control panel will be displayed until power returns. Spa settings will be preserved until next power up.
--		Temperature unknown.	After the pump has been running for two minutes, the current water temperature will be displayed
HH	OHX	"Overheat - The spa has shut down" One of the sensors has detected 118°F / 47.8°C at the heater.	DO NOT ENTER THE WATER. Remove the spa cover and allow water to cool. Once the heater was cooled, reset by pushing any button. If spa does not reset, shut off the power to the spa and call your dealer or service organization.
OH	OH5	"Overheat - The spa has shut down" One of the sensors has detected that the spa water is 110°F / 43.5°C.	DO NOT ENTER THE WATER. Remove the spa cover and allow water to cool to 107°F / 41.7°C. the spa should reset. If spa does not reset, shut off the power to the spa and call your dealer or service organization.
SA	SAA	Spa is shut down.* The sensor that is plugged into the sensor "A" jack is not working	If the problem persists, contact your dealer or service organization.(May appear temporarily in an overheat condition.)
Sb	SAb	Spa is shut down.* The sensor that is plugged into the sensor "B" jack is not working	If the problem persists, contact your dealer or service organization.(May appear temporarily in an overheat condition.)
Sn	SnS	Sensors are out of balance. If alternating with spa temperature, it may just be a temporary condition. If flashing by itself, spa is shut down.*	If the problem persists, contact your dealer or service organization.
HL	HFL	A significant difference between temperature sensors has been detected. This could indicate a flow problem.	If the water level is normal, make sure all pumps have been primed. If the problem persists, contact your dealer or service organization.
FL		Persistent low flow problems.)Displays on the fifth occurrence of message within 24 hours.) heater is shut down, but other spa functions continue to run normally.	Follow action required for message. Heating capability of the spa will not reset automatically, you may press any button to reset.
di		Possible inadequate water, poor flow, or air bubbles detected in the heater. Spa is shut down for 15 minutes.	If water level is normal, make sure all pumps have been primed. Press any button to reset. This message will reset within 15 minutes. If problem persists contact your dealer or service organization.
dy	di Y	Inadequate water detected in heater. (displays on third occurrence of message.) Spa is shut down.	Follow action required for message. Spa will not reset automatically reset. Press any button to reset manually.
IC	ICE	"Ice" - Potential freeze condition detected.	No action required. All equipment will automatically activate regardless of spa status. The equipment stays on 4 minutes after the sensors detect that the spa temperature has risen to 45°F / 7.2°C or higher. An optional freeze sensor may be added to protect against extraordinary freeze conditions. Auxiliary freeze sensor protection is advisable in colder climates. See your dealer for details.

OPERATING THE REST OF THE HOT TUB

DTS™ NORDIC STAR™ WHIRLPOOL JET(S):

Your hot tub is equipped with at least one Whirlpool Diverter jet (2, 3 or 4 positions depending on tub model purchased), located on the filter wall on most models. These jets, when turned, will divert water to either the Whirlpool Jet or to different groups of wall jets. Each position is reached with a 90 degree turn of the whirlpool jet face. It is recommended to turn the collar of the whirlpool diverter jet while the jets are in low speed operation and **turn clockwise** when possible. Remember, turning your diverter will affect the flow of water to different seat jets. Turn the whirlpool diverter to see which jets turn on/off in each position and adjust to suit your personal needs.

2-WAY DIVERTER:

With a 2-way diverter the whirlpool jet will either be on or off. If the whirlpool jet is on, the flow to the wall jets will be off and all the water will flow out of the whirlpool jet. If the whirlpool jet is turned off, the flow will be diverted equally to all the wall jets in the tub.

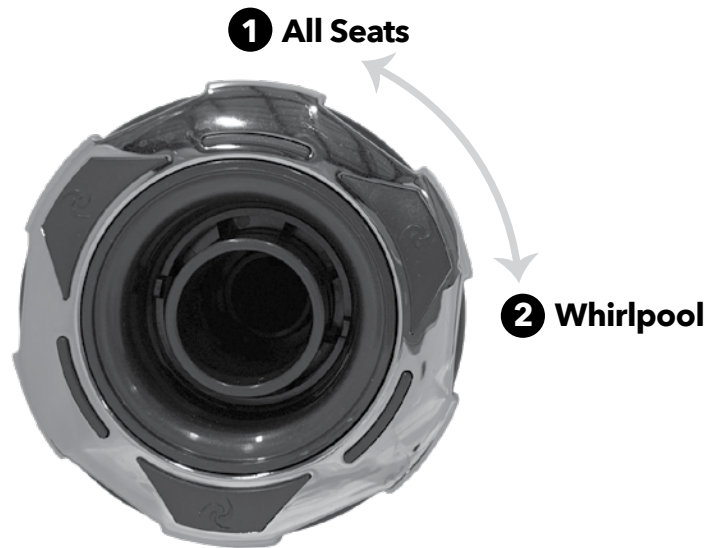

4-WAY DIVERTER:

With a 4-way diverter, the whirlpool jet will either be on or off. The other (3) positions direct water flow to different groups of wall jets depending on which model you have.

If the whirlpool is on all the flow goes thru the whirlpool and all wall jets are off. If you turn the whirlpool off you have 3 options to divert the water.

1. All the wall jets in the tub run equally.
2. Half the wall jets will be on the other half will be off.
3. Half that was previously on in option 2 will now be off and the half that was off will now be on. Remember the half that is on/off in option 2 & 3 depends on which model you own.
4. All of the water will come out of the Whirlpool jet

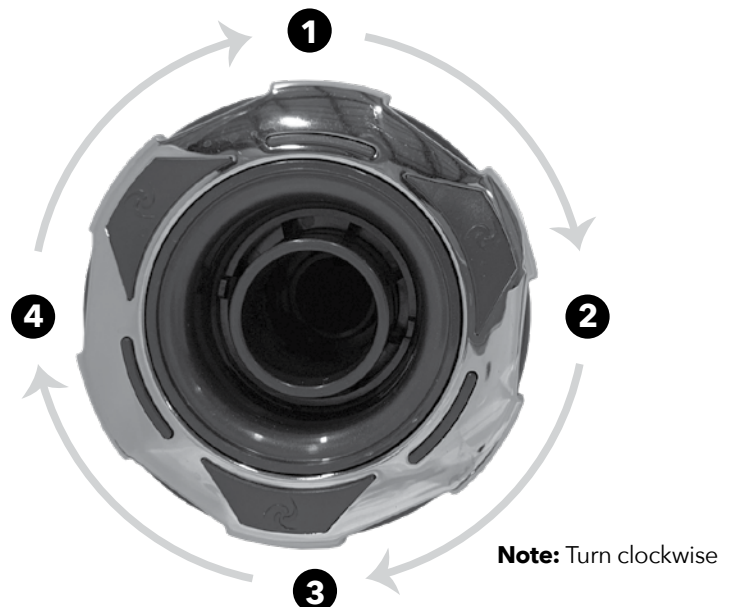

DUAL DIVERTER HOT TUBS

RENDEZVOUS LS

This model offers (2) 2-way whirlpool diverter jets. Each one will operate one half of the tub as described in the 2-way diverter section.

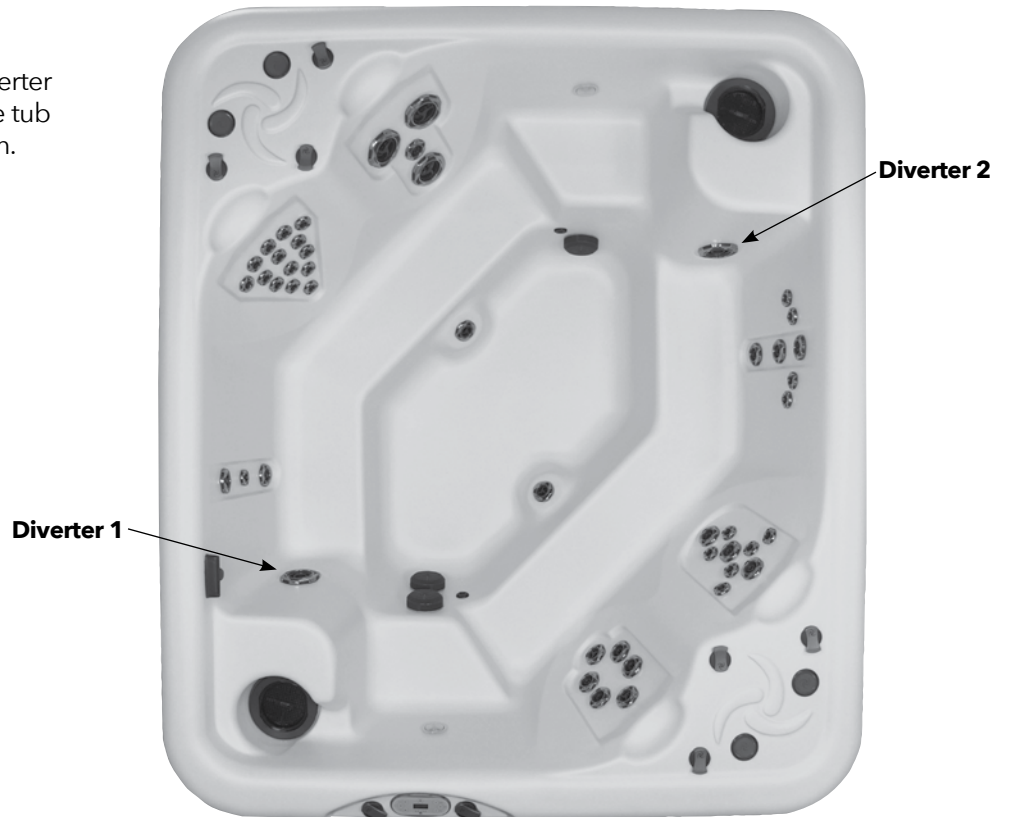

CROWN XL DTS™

The Crown XL is the only hot tub offered with (2) Whirlpool jets that affect one another. They also each have their own function and control certain seats.

The top diverter has (4) positions:

1. Only the Whirlpool Jet On
2. Only Seat 1 On
3. Only Seat 4 and 5 On
4. Seats 1,4, and 5 On

The Bottom Diverter has (3) positions:

1. Only the Whirlpool Jet On
2. Whirlpool and Seats 2 and 3 On
3. Whirlpool Jet off and additional pressure is applied to the jets to the top diverter.

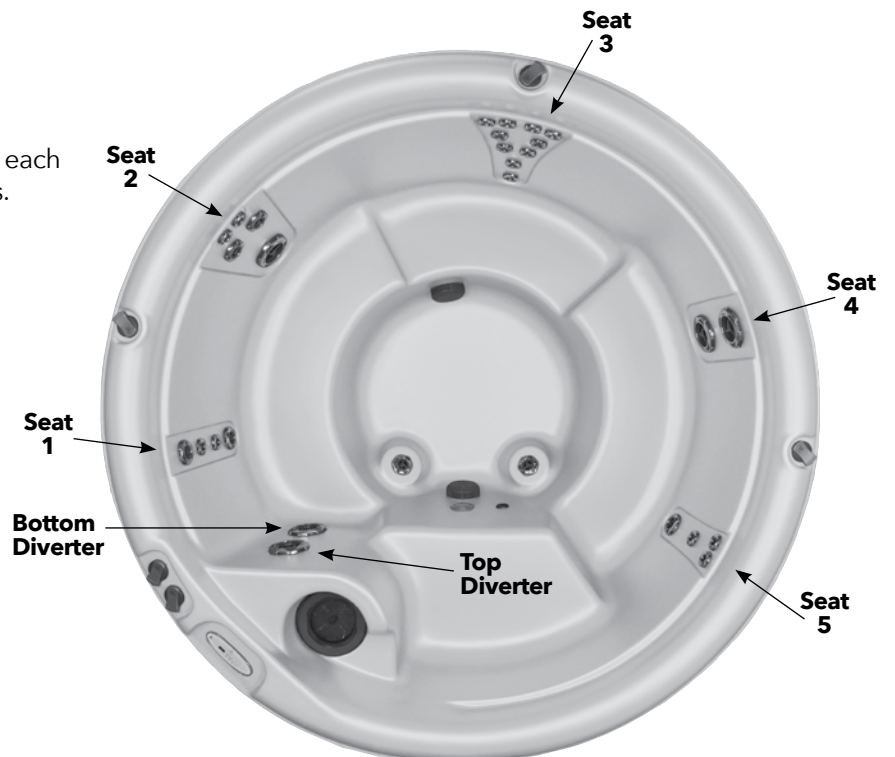

OPERATING THE REST OF THE HOT TUB CONTINUED

AIR CONTROLS:

Your hot tub has at least one air control. This air control allows air to mix with the water which streams out of your jets. Each air control is responsible for a section of jets or a whirlpool diverter jet. In order for the air control to have any effect, the jet(s) it controls must be on and have water flow. In extremely cold weather conditions, it is a good idea to rotate them to the off position when the tub is not in use to help maintain efficiency.

NOTE: Rotate, do not lift.

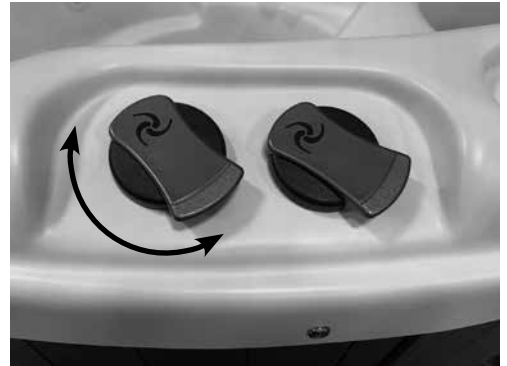

NORDIC STAR™ JETS:

There are several water jets which can be individually adjusted to customize the amount of waterflow through each. This feature allows you to create the perfect experience in each seat. To increase waterflow to a jet simply turn the jet counter-clockwise till you feel a stop in the turn. Jet should be fully open for maximum flow.

To turn a jet off, turn the jet clockwise till you feel a stop in the turn. The jet should be off. When the jet is turned off you will still feel a trickle amount of water through the jet for safety purposes.

These jets can be removed for cleaning or replacement by turning them fully counter-clockwise till you feel the stop and then continue an additional 1/16th turn to force it past the stopping point. Now the jet insert should be able to be pulled out.

To reinstall the jet simply align the nipple on the back of the jet with the groove in the jet housing on the wall, push the jet in and turn clockwise.

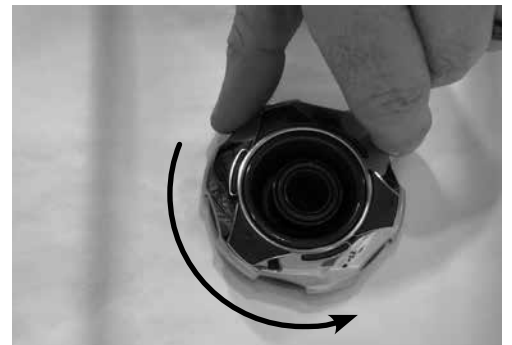

TOPSIDE CONTROL PAD:

Your hot tub is equipped with an electronic topside control pad. The topside control pad will allow you to control the speed of the pump, the light, and the temperature setting, as well as some programming options. Familiarize yourself with the topside control by viewing the Operation Guide on page 15.

LED LIGHTING SYSTEM:

The LED Lighting System consists of individual light nodes which are in coordination with the LED light housed in the light lens within the vessel of the spa. The light varies in color and function by pressing the light button. To turn on the system, simply press the button once. To turn it off, re-press the light button. To change the color or light function, press the light button quickly in succession. If the light has been off for more than 3 seconds it will resume at the last color setting selected. Certain models may receive the optional NLP™ Northern Light Package or the MLP™ Mood Lighting Package. The operation is the same but more items will be illuminated.

NORDIC CASCADE™ LED WATERFALL JET

The Nordic Cascade™ LED Waterfall jet has an angled design which allows for a beautiful arcing waterfall. The water flow can be controlled with the built-in adjustment handle. Just rotate it left or right to adjust the flow to perfectly meet the ambiance you desire.



FILTERS:

Periodic filter maintenance is required in order to maintain proper hot tub water quality and performance of equipment supplied with this hot tub. The manufacturer recommends cleaning your filters with high pressure water flow once a week. It is recommended filters be soaked in a quality filter cleaning solution once a month before high pressure spraying of the filter cartridge is applied. It can be removed for cleaning or replacement one of two ways:

1. If your hot tub has a floating weir, pull the weir straight up and then rotate the filter counter-clockwise until it is free and can be pulled straight out.



2. If your hot tub has a visible basket, just rotate the basket counter-clockwise to remove it. The filter will pull straight out.



TROUBLESHOOTING

New start-ups occasionally have an issue or two which need to be addressed. Don't worry- you can check some of these without calling for a service technician.

Symptoms	Solutions
No water movement (air lock)	T-valves must be in "UP" position or loosen (1) of the pump unions to allow the trapped air to escape
GFCI keeps tripping	Incorrect GFCI Wiring- ask service technician or electrician to verify wiring
Water in equipment area	Check: drain cap, pump and heater unions, pump plug
Only a portion of the jets work	Check that jets are open, rotate Whirlpool Diverter jet

Note: If problems persist after performing the suggested solutions, please contact your dealer to assist in resolving the problem. For any problems not listed above, please contact your dealer.

WARNING! Shock Hazard! No User Serviceable Parts.

Do not attempt service of this control system. Contact your dealer or service organization for assistance. Follow all owner's manual power connection instructions. Installation must be performed by a qualified, licensed electrician and all grounding connections must be properly installed.

WATER TREATMENT INSTRUCTIONS

WATER QUALITY

As the owner of a Nordic Hot Tub it is important to maintain proper water quality to keep your hot tub and equipment in excellent condition. Please consult your Spa and Pool Professional on how to maintain proper water quality. If your spa is equipped with an Ozone Generator, it will produce ozone only when the hot tub is running on low speed or during a filter cycle (2-pump systems). It cannot be used as the sole means to maintaining safe spa water- you will need to use sanitizers to keep your water sparkling and clean.

OZONATOR

Some models include an ozonator. Ozone reduces the required amount of sanitation chemicals required to keep your water clean, but it does not completely eliminate it. Any time pump 1 is running, ozone is being generated and injected into your hot tub via a small jet located in the footwell. The 2-pump systems only turn the ozonator on when it is running in a filter cycle.

SANITATION

Sanitizers are intended to kill bacteria and keep water clean. Nordic recommends Dichlor Granular Chlorine as a sanitizer. You will need to decide which brand sanitizer you wish to use. Please consult with your spa retailer for what is available and its proper use. They will have the best understanding of what is required to keep the water in your area balanced.

WARNINGS:

- The improper use of any sanitizing system including Dichlor Granular Chlorine could negate our warranty.
WHY?
 - Undissolved granules left on the shell surface can discolor, chemically burn, and blister the shell surface. This includes areas of the shell above the water line.
 - Slowly sprinkle the correctly measured granular products into the water. Directly over the filter basket or floating weir is an ideal location. For the Bella, slowly pour the granules near the side-mounted skimmer face.
- **WARNING: Do not confuse the term "Dichlor" with "Trichlor"- they are not the same. Trichlor is very acidic and will damage several components of your new hot tub.**
- The use of a **floater** can potentially damage the shell of your hot tub and is **not covered** under warranty. **Why?**
 - Floating dispensers have a tendency to end up staying

in 1 spot (near the filter). This causes the chemicals to disperse very quickly and it will be hard to manage the proper levels. Once the chemicals are gone, algae and bacteria can grow quickly.

- The increased chemicals getting continually drawn into the filter can stain or fade the shell. This is not covered under warranty.
- Floaters are typically loaded with larger tablets or bars. Small pieces of the chemicals (larger than granular products) can break off and settle on the seats and floors. Those can chemically burn, stain, or blister the surface.
- **Nordic does not recommend the use of any Bromine product. Why?**
 - Bromine can fade or discolor your shell surface. This is not covered under warranty
 - Bromine off-gassing combined with ozone can be dangerous in higher concentrations
- Do not use pool chemicals including muriatic acid or household bleach (liquid sodium hypochlorite)
- Do not use tablets or sticks. Only use granular products.
- Do not use polyhexamethylene biguanide products (hydrogen peroxide)
- Failure to maintain proper chemical balance (pH, Alkalinity, and Hardness) could also negate your warranty.
- **The use of Salt Systems will void the warranty.**

Remember: Your Nordic dealer is a trained chemical specialist and can assist you with your questions and water analysis if requested.

ADDING CHEMICALS

1. Lift the cover and fold it back and out of the way.
2. Turn the pumps on high speed.
3. Slowly sprinkle the correctly measured granular products into the water. Directly over the filter basket or floating weir is an ideal location. For the Bella, slowly pour the granules near the side-mounted skimmer face.
4. Let the spa run until it reaches the time-out time (approximately 15 minutes) at which point it will drop to low speed. Let it run on low speed for an additional 15-20 minutes before reinstalling the cover to allow all of the off-gassing to finish.

Note: Chemical off-gassing can damage your cover and void its warranty.

5. Reinstall the cover and latch or lock it.

Note: Chemical off-gassing can damage your cover and void its warranty.

UNDERSTANDING HOT WATER CHEMISTRY

Several things need to be checked and adjusted regularly. We will break things down for you in order to keep it as easy to understand as possible. You'll be a pro in no time, but please contact your authorized dealer to get started. They will know what works best for the water supply in your area. Your dealer will be able to supply you with water test strips to measure the items noted below. There are also drop-style testers available if you prefer.

STEP 1: TOTAL ALKALINITY (TA)

Total Alkalinity is the best place to start. It is the measure of the total levels of Bicarbonates, Hydroxides, Carbonites, and other alkaline substances in the water. An easy way to think of it is as a "buffer" for the pH. It is a measurement of the water's ability to resist changes to the pH level in the water.

- If the TA level is too high, the pH level will be difficult to bring down. Either add more water to your hot tub or add sodium bisulfate (pH/Alkalinity down).
- If the TA level is too low, the pH will fluctuate all over the place. Erratic pH can cause scaling and corrosion problems with your tub. Add sodium carbonate (pH/Alkalinity up) to correct.
- TA levels range from 20-180 with the ideal TA balance being **between 80 and 120**.

STEP 2: pH

pH is the measure of how acidic or alkaline your water is. Values above 7.8 are too alkaline and values below 7.2 are too acidic. If the pH is too high or too low, you risk damage to your spa shell, the equipment, and the water can be generally uncomfortable to enjoy.

- If the pH is too high (alkaline), the sanitizer will become less effective, scale can build up on the spa shell and equipment, the water may become cloudy, and the filter may become plugged. You can add sodium bisulfate (pH down) to the water to correct it.
- If the pH is too low (acidic), sanitizers will dissipate quickly, the water may corrode equipment, and make the water unpleasant to sit in. You can add sodium hydrogen carbonate (pH/alkaline up) to correct it.
- pH levels vary between 6.6 and 8.2 with **between 7.2 and 7.8 being ideal**.

NOTE: After adding pH up or pH down, it is important to wait at least 2 hours before re-testing the water.

STEP 3: CALCIUM HARDNESS (CH)

Calcium Hardness is the next thing to check. It is a measure of the total amount of dissolved calcium in the water. If there is too much dissolved calcium in the water, scale can build-up on the shell surface and inside the equipment. If it is too low, the water can become corrosive to the equipment.

- If the CH is too high, scale can build up on the shell surface and inside the equipment- this can damage the heater and pump. This is commonly referred to as "hard water". A generic calcium reducer will lower the CH in the water. A stain and scale inhibitor can also help reduce build-up.
- If your CH is too low, a general CH increaser can be added to the water.
- CH levels range from 75 to 275 on most scales and the ideal CH balance is **between 100 and 150**.

STEP 4: SANITIZERS

Sanitizers (ie: Dichlor) kills bacteria, algae, and other microscopic organisms as well as break them down for filtration to be effective. Chlorine levels are measured in PPM (parts per million) and occasionally need to be "shocked" to keep the levels in check. When they are correct, there is very little odor or irritation caused by the spa water. Most Nordic spas will require between ¼ and ½ ounce of granular Dichlor to get started.

NOTE: Do not add sanitizer until TA, CH, and PH are correct.

- Chlorine levels **between 3.0 and 5.0** are ideal without using an ozonator
- Chlorine levels **between 2.0 and 4.0** are ideal when you are using an ozonator.

Normal sanitation does not eliminate and filter certain forms of contamination which ends up in the water. Sun tan lotion, sweat, body oils, and hair spray, etc. require a little "kick" to help get them broken down for filtration. This "kick" is known as Shocking the water.

- Add 1 ounce of non-chlorinated shock a minimum of once every week.
- Additional non-chlorinated shock can help clear up cloudy water and unpleasant odors; or after heavy bather loads

NOTE: the spa must run on high speed a minimum of 30 minutes with the cover removed whenever shock is added. The cover can be damaged by the off-gassing from the shock treatment.

STEP 5: FILTRATION

Your new spa will require a certain amount filtration time to keep the water clean and sparkling. The factory default setting is F2 which means your hot tub will filter (2) continuous hours, twice a day. If you change the setting to F4, it will filter (4) continuous hours at a time twice a day. You may need more than this depending on the bather load and frequency of use. Your dealer or authorized service representative will be able to give you recommendations based on your anticipated use.

The default start time is the time you power-up your spa with the breaker. The first filtration cycle will begin within a few minutes of power-up. The 2nd filter cycle will begin 12 hours later. You can use this power-up timing to control when your hot tub runs. This is useful for avoiding on-peak electric charges or avoiding filtering during the heat of the afternoon in warmer climates. (this helps stabilize the temperature)

NOTE: Please reference the topside control instructions earlier in this manual for further instructions on setting the filter cycles.

Additional Note: Your dealer or authorized service representative will be your best resource for water chemistry-related questions that you may have. They will be happy to answer any questions that you may have.

DO'S AND DON'T S

- **Do** use only granular sodium dichlor (chlorine)
- **Do** remove the hot tub cover to prevent damage when adding chemicals and for 30 minutes after to allow for proper off-gassing
- **Do** sprinkle any chemicals onto the water surface unless it is above the filter (except Bella)
- **Don't** use any formed tablet or bar sanitizers
- **Don't** add chemicals into the filter basket, floating weir, or skimmer face
- **Don't** use a floater for chemical distribution
 - o They have a tendency to over-sanitize or under-sanitize your water
 - o Damage to the shell can occur
 - o This will not be covered under warranty
- **Don't** use any sanitizer that is not designed specifically for hot tub use
- **Don't** splash any chemicals on the shell or siding (please clean immediately with a garden hose and cloth)
- **Don't** use swimming pool (muriatic) acid to lower pH
- **Don't** use household bleach to sanitize the water (liquid sodium hypochlorite)

COMMON WATER Q & A

PROBLEM	CAUSE	SOLUTION
Calcium deposits on the shell surface	<ul style="list-style-type: none"> • Hard water. • pH, total alkalinity not in balance 	<p>Clean with a non-abrasive hot tub surface cleaner.</p> <p>Test water, adjust pH as needed.</p> <p>Add a stain and scale control chemical</p>
Cloudy water	<ul style="list-style-type: none"> • pH, total alkalinity not in balance. • Damages or dirty filter • Addition of incompatible chemicals • Low chlorine level • Buildup of oils, soap, foreign matter 	<p>Add a water clarifier. Circulate for a minimum of 30 minutes.</p> <p>Add water has cleared, clean filter cartridge with a filter cleaner or replace if necessary. Test chlorine and pH levels, adjust if necessary.</p> <p>Change water.</p>
Colored water	<ul style="list-style-type: none"> • Copper or iron metals in Hot Tub due to water supply or corrosion of heater. • Total alkalinity, pH are low. 	<p>Add an iron/stain and scale remover.</p> <p>Test pH, adjust if necessary.</p>
Excessive foam	<ul style="list-style-type: none"> • pH, total alkalinity not in balance • Low calcium hardness • Inadequate oxidation • Addition of incompatible chemicals • Buildup of body oils and/or contaminants 	<p>Add an anti-foam agent.</p> <p>Add shock.</p> <p>Adjust chlorine level.</p> <p>Test pH, adjust if necessary.</p> <p>Take water sample to dealer to check total alkalinity and calcium hardness. Change water.</p>
Eye and skin irritation	<ul style="list-style-type: none"> • pH, total alkalinity not in balance • Inadequate chlorine level • Addition of incompatible chemicals 	<p>Test pH and chlorine levels, adjust if necessary</p>
Odor	<ul style="list-style-type: none"> • Inadequate ventilation • Addition of incompatible chemicals • Insufficient oxidation • Inadequate cleaning of cover. • Low pH. • Chemical overdose 	<p>Test pH and chlorine levels, adjust if necessary.</p> <p>Clean with non-abrasive hot tub surface cleaner.</p> <p>Clean the underside of the cover with a cover cleaner or mild soap and warm water.</p> <p>Add shock.</p>
Waterline deposits and staining	<ul style="list-style-type: none"> • Buildup of body oils, impurities • Use of clarifying agents with ozone. • Hard water (minerals in water). 	<p>Test pH and chlorine levels, adjust if necessary.</p> <p>Clean with non-abrasive hot tub surface cleaner.</p> <p>Add a scale/stain control chemical.</p> <p>Take water sample to your dealer</p>

PERIODIC CLEANING AND CARE

Your new hot tub has been constructed to hold up to the elements for a lifetime and a little periodic cleaning will keep it looking new. Below is a list of how to care for the various components of your tub. Occasionally you will need to drain and re-fill your hot tub. We recommend every 3 months depending on the typical bather load and frequency of use. Water which remains cloudy after shocking is a clue it's time. This is the perfect time to clean the shell, siding, and cover as noted below.

DRAINING YOUR HOT TUB

1. Turn the power off to the hot tub at the GFCI breaker
2. Remove the access panel
3. Locate the drain



4. Remove the safety cap and connect a garden hose. Make sure to route the hose to a location that will not damage vegetation or erode sensitive landscaping
5. Rotate the handle on the drain assembly and let it empty until fully drained. It may be necessary to use a wet/dry shop vac to remove the last remaining water from the footwell and seat bases.
6. Close the drain valve, disconnect the garden hose, and reinstall the safety cap.
7. Reinstall the access panel, clean the shell, siding and cover (as noted below) and refill your hot tub.
8. Do not turn the power back on until the hot tub is full.

Note: You will need to balance your water since it has been refilled.

PERMASHELL®

PermaShell® cleans very easy because of its durable poly material. A spray pool and spa cleaner that is low in “suds” and is applied then wiped off will most of the time be sufficient. With stubborn stains or marks, a “soft” scrub cleaner with very low abrasion (elements) will help when used with a non-abrasive cleaning pad. A Magic Eraser works as well.

HIGHWOOD® - MAHOGANY, TEAKWOOD, CHARCOAL, BLACK

Maintenance for Highwood® is to use mild soap and water. Some strong household cleaners/solvents can cause damage/fading to the surface of the cabinet. All cleaners should be tested on an out-of-the-way section of cabinet before cleaning.

WESTERN RED CEDAR

As with any wood product, maintaining the “new” look requires a consistent schedule of treating your cabinet with a quality Tung or Teak Oil product. Either can be easily applied by wiping it on with a clean rag or sponge.

COVER OR HOT TUB LID

See manufacturer's warranty and maintenance procedures.

When adding any chemicals like a “hot tub shock”, the cover must be removed for 30 minutes. Failure to remove cover may cause damage to cover.

NOTE: Please visit www.nordichottubs.com for more information and tips regarding use and cleaning

WARNING: The improper use of any sanitizing system including Di-Chlor Granular Chlorine could negate our warranty. The use of Bromine or Chlorine tablets in a floater or Biguanide Chemicals can potentially damage (fade) the shell of your hot tub and is not covered under warranty. Failure to maintain proper chemical balance (pH, Alkalinity, and Hardness) could also negate your warranty. Nordic does not recommend the use of any Bromine product with Ozone. The use of Salt Systems will void the warranty.

WINTERIZING YOUR HOT TUB

While we feel some of the best times to use your spa can be during the colder months, we understand there can be a need for some owners to close their tubs during the winter months. We feel winterization should be left to the professionals, but if done carefully using the following instructions, your risk of damage from freezing can be minimized. Please note, we do not warrant against freezing damage in a tub which has been inappropriately winterized, either by the owner or by a professional service center.

WINTERIZING INSTRUCTIONS

Things that will be needed:

- 2-3 gallons of NON-TOXIC (R-V type) antifreeze
- a strong wet/dry vacuum (shop vac)
- a turkey-baster
- 1 or 2 light plastic bowls approximately 5" diameter
- TIME approx. 2 hours

Instructions

1. Drain your tub. Inside the equipment room there is a spigot for a garden hose. It is attached to a clear vinyl hose near the main control box.
2. With a wet-vac, remove any water remaining in the foot-well. Then with each jet in the open position, vacuum each jet nozzle until no more water comes out. **DO NOT FORGET** the small ozone jet in the foot-well.
3. With the vacuum over the whirlpool jet nozzle(s) and plastic bowls over the suction covers in the footwell, change it to each diverter position until there is no more water being drawn out.
4. Remove your filter, clean it and place in storage until you restart your tub. Pour NON-TOXIC antifreeze into the filter canister until it runs out into the foot-well of your tub through the suction covers.
5. With the turkey-baster, squirt a small amount of NON-TOXIC antifreeze into each jet. Usually the side jets will take around one ounce, and the whirlpool jet(s) will take several ounces (about 5 squirts per whirlpool jet). **DO NOT FORGET** the small ozone jet that is located in the foot-well of your tub.
6. Place the cover on the tub, and place a tarp over the tub and cover. Making sure to securely tie down the tarp. The tarp will help reduce the amount of weather your tub is exposed to.

A couple of things you should be aware of:

When a tub is drained and left empty, o-rings and pump seals can dry out and lose their ability to seal properly. You should closely inspect for small leaks in the equipment area when you perform your restart. If you are unsure of the location of the o-rings and pump seal, contact your dealer for help. If replaced early the damage caused by these failures can be inexpensive to fix.

RE-START

When restarting your tub, you will want to fill the tub and run all of the jets on high speed for 10-15 minutes. This will help flush the residue of the antifreeze out of the plumbing. Then drain the tub, clean the sides with an approved cleaner, place your filter back into the filter canister, re-fill your tub and balance your chemicals.

You may notice slightly more foaming than normal when you first start using your tub, this can be reduced with anti-foaming agents and generally gets better over the first week or two of usage as the filter removes the anti-freeze and organic residue left behind after rinsing and cleaning.

Make sure you check your filter at least once per week and rinse it out as needed for the first few weeks. You may also find it necessary to soak your filter in a filter cleaner after a few days, depending on the level of contaminant left in the tub after the re-start.

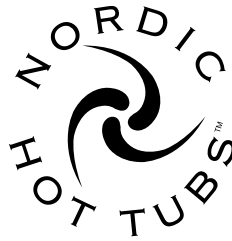

HOT TUB WARRANTY REGISTRATION

TWO WAYS TO REGISTER YOUR NORDIC HOT TUB:

Option 1: Online at www.nordichottubs.com

Option 2: Fill out form below, remove this sheet from the manual and mail your registration in an envelope to:

NPI / HOTTUBS
4655 Paterson Ave SE
Grand Rapids, MI 49512-5337

WARRANTY REGISTRATION FORM

Model _____ Shell Color _____ Delivery Date _____

Serial Number _____ (Located in the equipment compartment and outside warning label)

OWNER INFORMATION

Name _____

Address _____

City _____ State / Province _____ Zip Code _____

Country _____ Phone Number _____
(Please include international & area codes)

Email _____

DEALER INFORMATION

Name _____ Installation Location _____

Address _____

City _____ State / Province _____ Zip Code _____

Country _____ Phone Number _____

Email _____

I have read the Warranties and accept the terms there stated.

Owner's Signature _____ Date _____

WEEE WASTE RECYCLING

WEEE Directive 2012/19/EU: The marking on the product, accessories, or literature indicates the product and its electronic accessories should not be disposed of with other household waste at the end of their working life. You must dispose of your waste equipment and/or battery by handling it over to the applicable take-back scheme for the recycling of electrical and electronic equipment and/or battery. For more information about recycling of this equipment and/or battery, please contact your city office, the shop where you purchased the equipment or your household waste disposal service. The recycling of materials will help to conserve natural resources and ensure it is recycled in a manner which protects human health and environment.

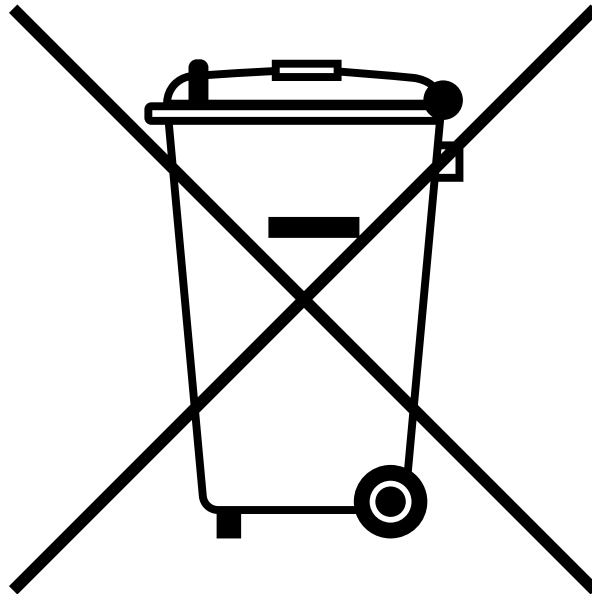

NO ELECTRICAL WASTE

QUICK REFERENCE

QUICK REFERENCE BY MODEL

Model	Measurements	Operating Capacity (US Gallons)	Dry Weight (lbs)
Impulse	Diameter: 78.5 x 31 deep	265	270
Crown	Diameter: 84 x 35 deep	275	345
Sport, Crown II, and Impulse DP	Diameter: 78.5 x 35 deep	280	335
Warrior XL and Crown XL	Diameter: 84 x 38.5 deep	330	400
Bella	83 x 34	135	270
D'Amour	84 x 72	205	350
Stella	84 x 62	240	415
Retreat	80 x 70	250	400
Escape	82 x 80	300	450
Jubilee	84 x 84	325	470
Encore	84 x 84	330	475
Rendezvous	96 x 84	375	625

VOLTAGE AND AMPS BY SERIES

Series	Voltage	Amps Used	Recommended Breaker Size
All-In-110 Series	110Volt	12	15 amp cord included
Classic Series	110/220 Convertible (except Crown XL)	12/31 or 15/31 (except Crown XL)	15/40 or 20/40 amps* (except Crown XL)
Modern Series	110/220 Convertible	15/31	20/40 amps
Sport Series (and Crown XL)	220 Volt	30	40 amps
Luxury Series	220Volt	42	50 amps

- 15 or 20 amp when converted for 110 volt use
- 15 amp when 1.0HP pump installed, 20 amp when 1.5HP pump installed



nordichottubs.com